



# NDT-RAM SYSTEMS SELECTION GUIDE

# ABOUT THE MODAL SHOP

**“SIMPLIFYING PEOPLE’S LIVES WITH SMART SENSING SOLUTIONS THAT HELP IMPROVE THE PERFORMANCE OF PEOPLE, PRODUCTS AND PROCESSES.”**

Non-Destructive Testing Resonant Acoustic Method systems from The Modal Shop were engineered with your desire for 100% in-line inspection in mind. The NDT-RAM Team knows what it’s like to go to sleep at night worried that a call will come in at 2 AM. We are here to help simplify your lives with our line of objective quality inspection systems. For nearly 20 years, our team has been serving facilities around the world. Your quality and process issues are our business.

When you have a question or need technical assistance, you’d like to have an answer sooner rather than later. That’s common sense. Our commitment to be available is one of the cornerstones of our promise to you. Email us at [ndt@modalshop.com](mailto:ndt@modalshop.com) to learn more or call us at 513.351.9919 to speak with our team.

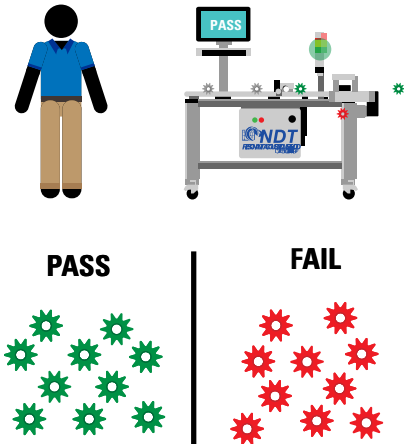

## NDT-RAM SYSTEMS



### RAM-AUTO Fully Automated System

A turnkey Resonant Inspection system with automated conveyor and industrial grade computer.



### RAM-DROP Small Part System

Fast inspection system for small parts with automatic sorting of defective parts.



### RAM-TEST-FIXTURE Test Station

Resonant Inspection workstation with an adjustable platform for easy testing of various part sizes and shapes.



### RAM-TEST-SEMI Semi-Automated System

Resonant Inspection system - ideal for integration into an existing manufacturing process.



### RAM-TEST-MANUAL Manual System

A portable system ideal for spot checks and troubleshooting in the field and new part set-up.

# NDT-RAM SYSTEMS SELECTION GUIDE

## TABLE OF CONTENTS

### NDT-RAM Overview

Ensure Zero Defects	04
NDT-RAM Working for You	04
Detect Variances	05
NDT Method Comparison	05
Resonant Acoustic Method Simplified	06
Why NDT-RAM?	07
Systems Installation and Training	07

### NDT-RAM Systems

Automated Solutions	8
Small Part Quality	10
Versatile Inspection	12
Integrate In-Line	14
Test On-Site	15

### NDT-RAM in Action

Capstan Atlantic Case Study	16
NDT-RAM Testimonials	19

## THANK YOU FOR CHOOSING THE MODAL SHOP

Thank you for choosing The Modal Shop and NDT-RAM as your partner in quality inspection and process monitoring. We invite you to learn about the products and services in the following pages and on our website – [modalshop.com/ndt](http://modalshop.com/ndt). We look forward to helping you reach your goal of 100% quality inspection! As always, The Modal Shop's NDT-RAM Team is just a call or click away. You can reach us at 513.351.9919 or [ndt@modalshop.com](mailto:ndt@modalshop.com).



#### Video Vault

We believe that you should have easy access to support, no matter where you are. Our site offers a growing list of NDT-RAM video tutorials, available 24 hours per day, 7 days per week at [www.modalshop.com/videos](http://www.modalshop.com/videos).



#### Information and Downloads

From application information to downloadable catalogs, datasheets and whitepapers, you can find a complete range of resources simply by visiting [modalshop.com/ndt](http://modalshop.com/ndt) and navigating to your area of interest.



#### Technical Paper Archive

A selection of technical papers and articles focusing on Resonant Acoustic Method technology and applications is available at [www.modalshop.com/ndt/NDT-RAM-Technical-Paper-Archive?ID=754](http://www.modalshop.com/ndt/NDT-RAM-Technical-Paper-Archive?ID=754). New topics are added regularly.



#### FAQ

Whether you are interested in learning more about which system will best suit your needs or how a rental system can help you get started with 100% in-line inspection, you'll find answers quickly and easily by visiting our homepage at [modalshop.com/ndt](http://modalshop.com/ndt).

# ENSURE ZERO DEFECTS

In world class manufacturing today, the result of shipping a defective part can be catastrophic. The NDT-RAM Resonant Acoustic Method systems – per ASTM E2001 – are designed to fully inspect parts, economically and on time, giving you and your customer confidence in part quality. Our range of systems can help you meet your goals no matter what the environment.

The principle of NDT-RAM is simple. Every part has a unique resonant signature that reflects its composition. Any deviation from the expected signature indicates the presence of a structural flaw or variation. A familiar example is a cracked bell that no longer has a clear ring and cannot hold its tone.

With no part preparation required, this technique can objectively identify resonant frequency shifts caused by internal and external

flaws due to cracks, voids, material density, brazing integrity and missed manufacturing processes, eliminating errors that come from human interpretation. The entire procedure takes only seconds per part, allowing for efficient quality control testing of all the parts in your process line.



ARE THESE PARTS GOOD OR BAD?

## NDT-RAM WORKING FOR YOU

The NDT-RAM Team understands quality challenges. Each system is designed to meet the needs of the user with the end goal of providing 100% inspection for all parts.



### PRODUCTION TEAM

- **Clean** - no need for cleaning, magnetizing, dye or other messy part preparation
- **Easy to Use** - simple terminology makes NDT-RAM easy to learn, operate and implement
- **Fast** - parts are fully inspected approximately one per three seconds



### QUALITY MANAGER

- **Accurate** - computerized Pass/Fail acceptance ranges ensure inspection accuracy
- **Smart** - detailed report generation with statistical analysis, are easily created
- **Secure** - provides password protection for three user levels: manager, technician, inspector



### PLANT MANAGER

- **Time-Saving** - eliminate time lost on manual or slow inspection and containment methods
- **Versatile** - system can test many different parts: pick from a pull-down menu and begin testing
- **Rugged** - designed to withstand a wide range of plant environments with NEMA4 enclosure



### EXECUTIVE/OWNER

- **Trust-Building** - customers expect quality; confidently provide 100% inspection
- **Economical** - test faster, reduce scrap, rework, consumables and more - ROI analysis available
- **A Smart and Safe Choice** - free feasibility study and our Total Customer Satisfaction guarantee

# DETECT VARIANCES

Resonant Acoustic Method is a unique form of Resonant Ultrasound Spectroscopy (RUS), also popularly known as Resonant Inspection (RI). The ASTM E-2001 standard addresses Resonant Inspection. The Resonant Acoustic Method (NDT-RAM™) provides a whole body component inspection sensitive to both internal and external flaws. NDT-RAM can detect anomalies and imperfections such as variances in overall shape, weight and density of parts. It can also detect if processes, such as machining or heat treating, have been missed.

PROCESS	TYPICAL FLAWS
Powdered Metal (PM, MIM, AM)	Cracks, Chips, Voids, Hardness/Density, Inclusions, Heat Treatment, Decarb, Brazing, Gross Dimensions, Raw Material Contaminants, Missed Processes/Operations
Forging	Cracks, Missed or Double Strikes, Hardness, Inclusions, Heat Treatment, Quenching Problems, Laps, Gross Dimensions, Raw Material Contaminants, Missed Processes/Operation
Ductile Casting	Cracks, Nodularity, Tearing, Wall Thickness, Inclusions, Heat Treatment, Misalignment, Wrinkles/Laps, Gross Dimensions, Raw Material Contaminants, Missed Processes/Operations

PROCESS	TYPICAL FLAWS
Other Castings	Cracks, Cold Shuts, Hardness/Density, Inclusions, Heat Treatment, Residual Stress, Nodularity, Gross Dimensions, Raw Material Contaminants, Missed Processes/Operations
Welding/Brazing	Weld/Braze Quality, Missing Weld/Brazing, Cold Weld, Double Brazed, Incorrect Braze Quality, Inclusions, Non-Uniform Weld/Flow, Misalignment, Voids, Gross Dimensions, Raw Material Contaminants, Missed Processes/Operations
Other/Common defects	Crack, Missed Ops, Mixed Product, Missing material, Heat Treat, voids, Contaminations, Density, ETC

# NDT METHOD COMPARISON

Resonant Acoustic Method (RAM) Resonant Inspection offers a favorable test method providing 100% testing with no special part preparation. RAM is compared with other common Non-Destructive Testing methods below.

DEFECT TYPE	RAM Resonant Acoustic	ET Eddy Current	MT/PT Magnetic Particle	UT Ultrasonic	RT Radiography
Cracks/chips/voids	■	■	■	■	▲
Missed processes/operations	■	●	●	●	▲
Material property	■	●	●	●	●
Structurally significant	■	■	■	■	■
Product lot variations	■ ▲	▲	■	■	■
<b>DEFECT LOCATION</b>					
Surface (external)*	■	■	■	■	●
Internal	■	●	●	■	■
Brazing/bonding/welding	■	●	●	▲	▲
<b>SPEED/TRAINING/COST</b>					
Part throughput	■	▲	▲	■	●
Training requirements	■	●	●	●	●
Overall inspection costs	■	▲	▲	●	●
<b>AUTOMATION CAPACITY</b>					
Quantitative results	■	●	●	▲	●
Ease of automation	■	▲	▲	●	●
Automation cost	■ ▲	▲	●	●	●

■ Excellent    ▲ Fair    ● Poor

\*NDT-RAM does not detect cosmetic flaws

# RESONANT ACOUSTIC METHOD SIMPLIFIED

To help explain the Resonant Acoustic Method (NDT-RAM), let's consider how a person can determine between a good bell 🟢 and a cracked bell 🔴

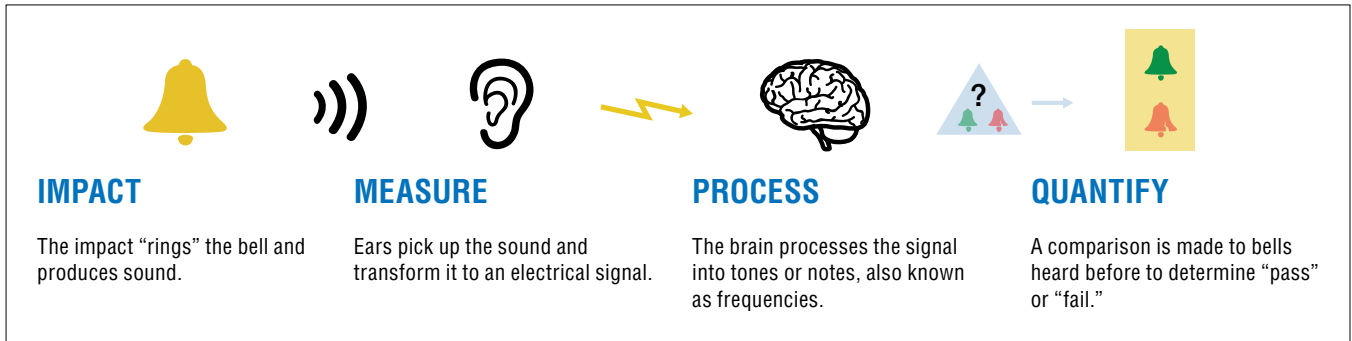

Resonant Acoustic Method and the NDT-RAM System perform exactly the same way, but can objectively discern between small differences in complex parts that produce far more tones than a bell. NDT-RAM also measures acoustic differences far beyond the range of human hearing.

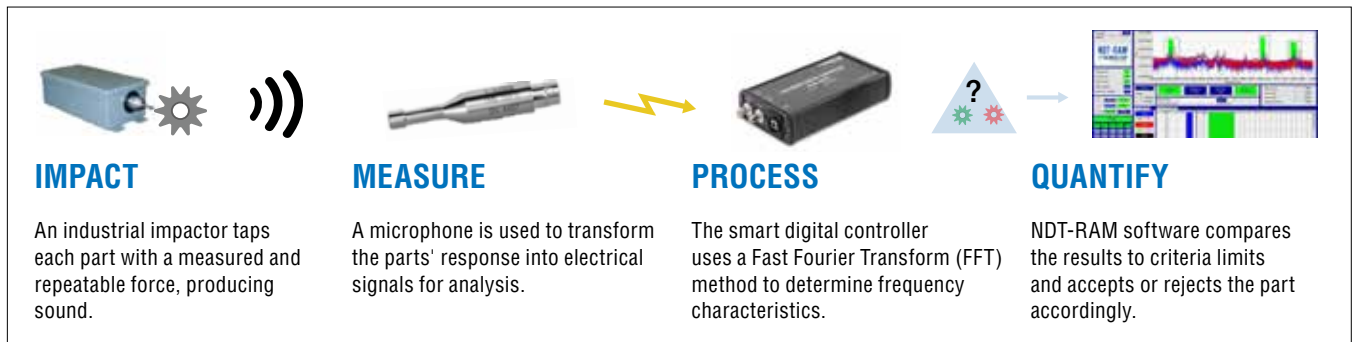

## TEST TALK: PASS / FAIL TECHNOLOGY

The resonances of a structure are defined by its mass, stiffness and damping. These resonant frequencies can be measured in most rigid materials including metals, ceramics and composites. NDT-RAM systems detect frequency shifts which are caused by imperfections such as cracks, or voids as well as

variances in nodularity, dimension, geometry, weight, density and manufacturing processes.

Changes in mass, stiffness and damping due to certain defects can cause...

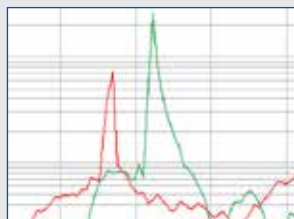

...resonant frequency peaks to shift in both frequency and amplitude.

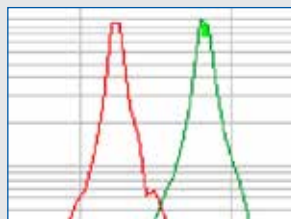

...resonant frequency peaks to shift in frequency but maintain amplitude.

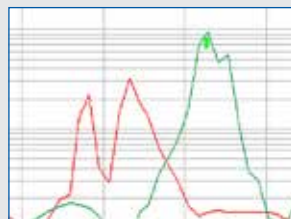

...peak shifts with more pronounced splits in resonant frequency.

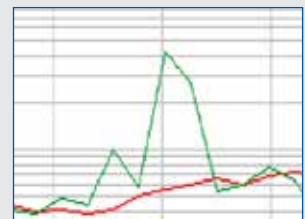

...resonant frequency peak energy to disappear completely.

# WHY NDT-RAM?

The Modal Shop, Inc. (TMS) offers a simple process to assess the benefits of using market-leading Resonant Inspection NDT-RAM systems in your facility. Resonant Inspection systems are an effective solution for monitoring process quality in components. The trial process is as user-friendly as the NDT-RAM system is itself and each member of your team will get answers to their most important questions.

## Free Parts Test

Is RAM right for your parts? Find out with a no-risk assessment!

- Send a controlled set of known “good” and “bad” pieces to TMS
- TMS tests parts to determine compatibility with NDT-RAM technology
- Test Results and Feasibility Report provided via Webex or face-to-face meeting/demo

## NDT-RAM System Rental

Rental provides solutions to “try before you buy” and for high-demand or quarantine situations.

- Rental hardware ranges from Manual and Drop Test to fully Automated Systems
- Experience full benefits of 100% inspection in your production environment
- On-site training and follow-up ensures your team’s comfort and proficiency
- You’ve rented it and love it? Great! 100% of the first month’s rental fee is applied toward purchase.

## 3. SYSTEM PURCHASE – ONE-YEAR WARRANTY

Ready to buy? Accrued rental credit is applicable for 12 months from the start of the rental period. Purchase comes backed by The Modal Shop’s commitment to Total Customer Satisfaction and a one-year warranty.

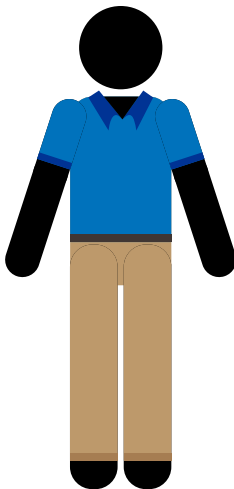
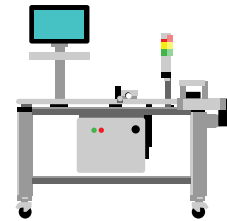
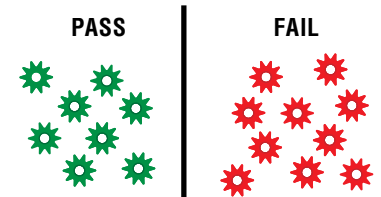

## SYSTEMS INSTALLATION AND TRAINING

Each NDT-RAM System includes on-site installation and training. Our commitment to you is Total Customer Satisfaction — we work closely with you to make your quality inspection process simple and effective. The Modal Shop’s NDT Team works one-on-one with plant management, process engineers, testing technicians and line inspectors to ensure a successful start to your NDT-RAM experience. Our on-site training includes the following:

- Analyzer Set-up and Automation
- Proficiency with NDT-RAM Software
- Establishing Acceptance Criteria
- Customization of Limits
- Generating and Analyzing Reports
- Supplemental Parts
- Hardware and Automation Overview
- Troubleshooting and FAQs
- Part changeover
- Process Monitoring
- Special Requests and More...

The Modal Shop’s NDT-RAM Engineering and Customer Service Teams remain involved and invested in your testing process long after installation and on-site training are completed. We are committed to supporting you in your testing efforts for the life of your system.

# AUTOMATED SOLUTIONS

## RAM AUTOMATED SYSTEM

MODEL RAM-AUTO

The RAM-AUTO system is an easily integrated, in-line production solution to ensure quality.

- Automated conveyor provides throughput as quickly as 0.5 seconds per part
- Quick Pass or Fail response for high-volume production lines
- Customizable to use with a variety of parts and geometries
- Ready for production – use out of the crate





# 100% IN-LINE INSPECTION



The Modal Shop's fully automated RAM-AUTO System is an ideal choice for your goal of 100% in-line inspection. The RAM-AUTO System is perfect for applying efficient and reliable quality control testing to high-volume production lines of powdered metal parts, castings and similar components. The system stands alone and can be moved directly into any production line. RAM-AUTO Systems require no user intervention during testing and deliver an objective Pass or Fail for each part with automated sorting.

Each RAM-AUTO System includes an industrially packaged, 24-bit, 50 kHz smart digital controller as its core, with an industrial impactor and rugged microphone as sensors. Additionally, the system includes a production line conveyor, photoelectric eyes, PLC, encoder and industrial PC with integrated flat panel monitor to create a complete turnkey package for testing.

## KEY SPECIFICATIONS

Part Testing Rate	Minimum 0.5 seconds, typical 1-3 s *
Part Types Tested	Metal, ceramic, high-stiffness composition
Criteria Ranges	Up to 20 per part setup
Power Requirements	200VAC, Single Phase, 10 Amps
Air Requirements	Regulated 60 – 90 psi (414 – 621 kPa)
Overall Dimensions	6 x 4 x 6 feet, typical (1.8 x 1.2 x 1.8 m)

\*Throughput dependant on part size and system setup.

## TEST TALK: SINTER BRAZING

Testing the structural integrity of complex powdered metal parts joined via sinter braze is a critical step in ensuring the part will perform as designed. Incomplete braze infiltration, improper braze alloy, damaged or even missing braze pellets can be difficult or impossible to detect via visual inspection or traditional methods of Non-Destructive Testing.

NDT-Resonant Acoustic Method (NDT-RAM) provides an extremely fast, whole body indication of braze integrity on 100% of parts produced. Resonant frequency shifts caused by the structural weakness of poor sinter brazing are readily detected. In addition, the system acts as a process monitor if the failure rate increases beyond the norm. The process can be halted, investigated and the root cause determined sooner, saving time and money on scrapped parts.

By comparing the resonant frequency shifts to visual and destructive test results, NDT-RAM can easily, objectively and

reliably detect poor sinter brazed joints. The capability of automating NDT-RAM makes it superior to subjective visual or inefficient and costly destructive tests.



Part Characterization Induced Defect	Separation Force, Lbs (N)
Good parts	26,118 (116,180)
(1) Missing braze pellet	13,360 (59,430)
(2) Missing braze pellets	8,121 (36,124)
(3) Missing braze pellets	4,288 (19,074)
Misaligned sub-	8,129 (36,160)
Small braze pellet	8,812 (39,198)
Poor sinter	5,995 (26,670)



# SMALL PART QUALITY

## RAM-DROP SYSTEM

MODEL RAM-DROP

Automated testing of small parts is made easy with the Drop System

- Automates easily with typical small part automation components like bowl feeders or vibratory tables
- Laboratory grade instrumentation packaged for a rugged manufacturing environment
- Fast, easy adjustment for testing multiple different part numbers



# 100% AUTOMATED INSPECTION

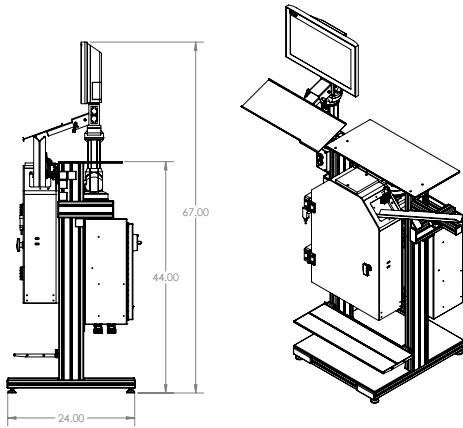

## KEY SPECIFICATIONS

Part Testing Rate	Minimum 0.5 seconds, typical 1-3 s*
Part Types Tested	Metal, ceramic, high-stiffness composition
Available Criteria Ranges	20
Overall Dimensions	24 x 48 x 67 inches, typical (0.6 x 1.2 x 1.7m)
Overall Weight	Approximately 250 lb (113 kg)

\*Throughput dependant on part size and system setup.

The Modal Shop's NDT-RAM Drop System, RAM-DROP, is an ideal choice for 100% inspection of small component parts. The RAM-DROP system offers automated sorting and quality testing of powdered metal and other small parts. Testing is quick and efficient, with typical cycle times at approximately three seconds per part. The RAM-DROP provides a means for objective sorting requiring no human interpretation. A simple Pass or Fail result is returned by the NDT-RAM system and parts are automatically sorted via servo-controlled motor.

Integrating an industrial PC, free-standing Drop Testing enclosure, smart digital controller, force sensor and microphone, this turnkey system is designed to withstand continuous operation in plant floor environments. This easy-to-use system can detect imperfections or flaws such as cracks, missing features and mixed parts. It can also detect if processes have been missed, such as a machining or heat treating operation.

## TEST TALK: CARBIDE TOOLING

Deburring, milling, drilling, and other bits that rotate at medium or high speeds can cause significant damage and severe injury if a weak braze joint or crack propagates to failure while the part is in operation. Incomplete braze infiltration, improper braze alloy, damaged or even missing braze pellets or paste can be difficult or impossible to detect via subjective visual inspection or other traditional methods of non-destructive testing. These same methods may also indicate a poor braze joint while mechanical testing of the same part can show separation force is well above the required limit.

Tooling bits, with or without braze joints, can be tested using NDT-RAM (Resonant Acoustic Method). NDT-RAM is able to provide an extremely fast, objective, whole body indication of the integrity of the part on 100% of the parts produced. Resonant frequency shifts caused by the structural weakness of poor sinter brazing are readily detected. Performing quality inspection using an NDT-RAM system provides peace of mind that only good parts are shipped to the

customer. The database output of an NDT-RAM system offers the added benefit of real-time monitoring of the manufacturing processes. In addition, early indications of process changes or failures can help to significantly improve daily operational costs and efficiencies.

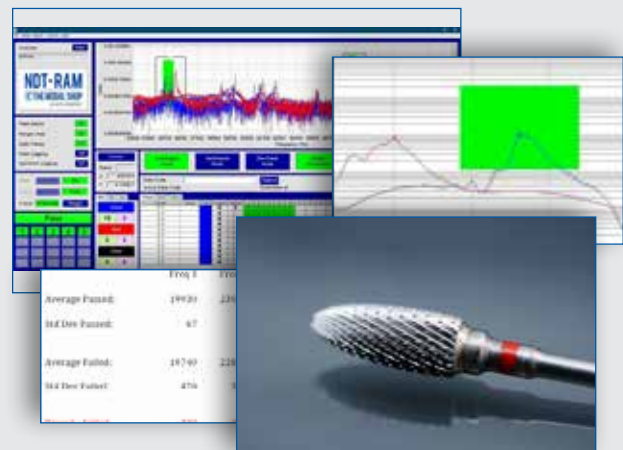

# VERSATILE INSPECTION

## RAM TEST FIXTURE

MODEL RAM-TEST-FIXTURE

Automated workstation with an adjustable platform for easy testing of various part sizes and shapes. Ideal for:

- Larger parts with complex geometry
- Job shops or any short run manufacturing
- Inspection not requiring high throughput rates
- Elimination of manual sorting in quarantine situations
- 100% inspection with manual or robot loading/unloading.

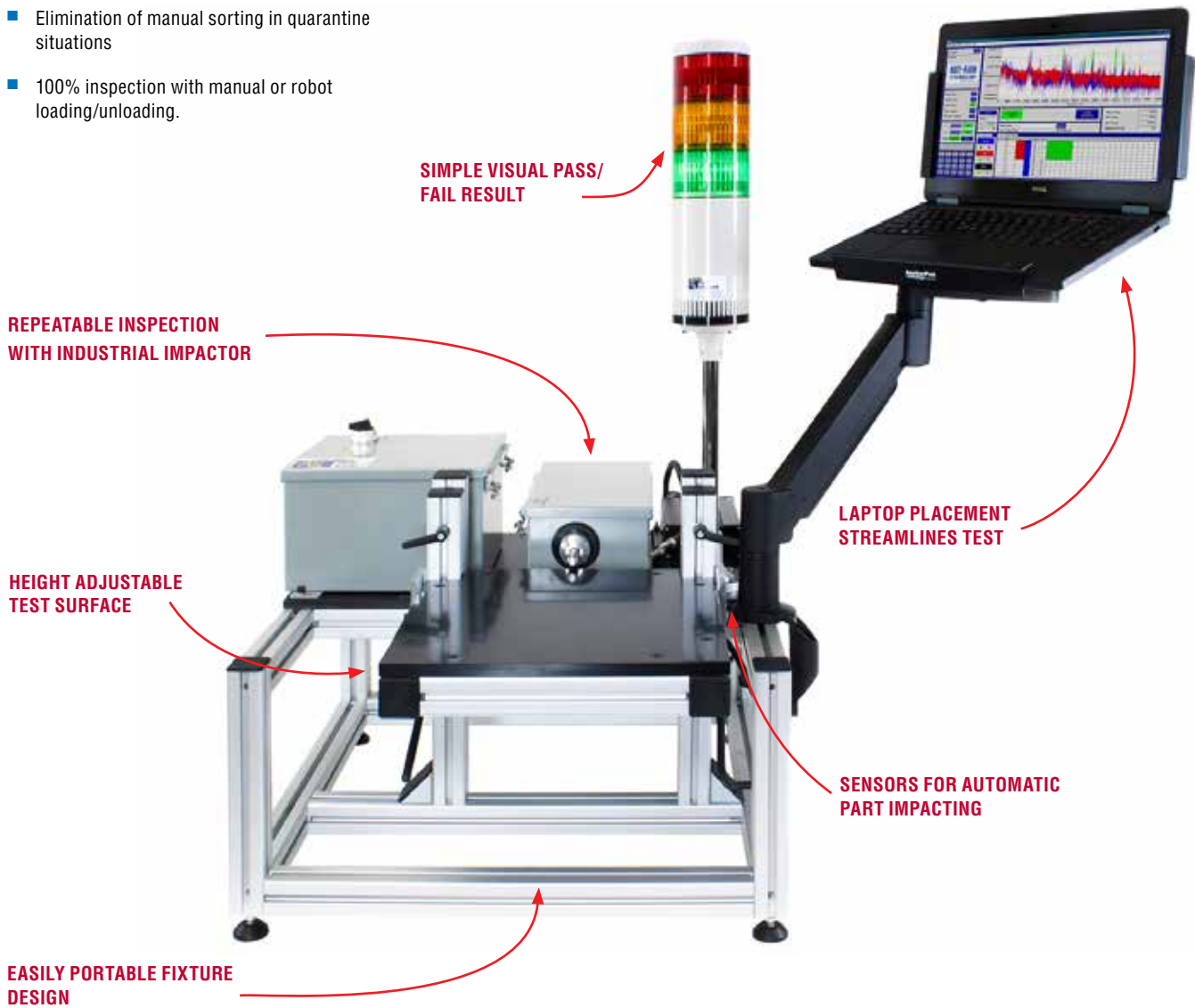

# REPEATABLE MANUAL INSPECTION

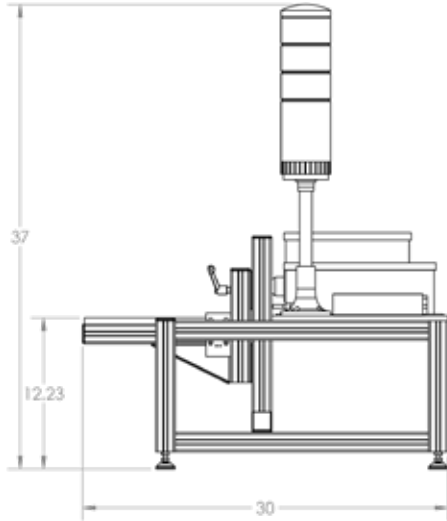

The Modal Shop's NDT-RAM Test Fixture, RAM-TEST-FIXTURE, is an ideal choice when repeatable manual inspections are required. The innovative RAM-TEST-FIXTURE provides precise control of part positioning with an adjustable table ranging up to 6.25 inches in height variation. When a part is in position, photo eye sensors trigger the integrated industrial impactor.

Once impacted, the objective part inspection requires no human interpretation. The system includes a laptop PC on a swing arm, running NDT-RAM software which acquires data for analysis from each part and then delivers a simple Pass or Fail result. The included light tower provides a clear, visual indication of a part's test status after impact for the operator to sort the part accordingly.

## KEY SPECIFICATIONS

Part Testing Rate	Manual, 5 to 10 seconds per part, typical
Part Types Tested	Metal, ceramic, high-stiffness composition
Available Criteria Ranges	20
Overall Dimensions	24 x 30 x 40 feet, typical (51 x 76 x 102 cm)
Overall Weight	90 lb (40.8 kg)

## TEST TALK: METAL CASTING

An automotive parts supplier of brake anchors was experiencing cracks in the finished parts. Heavy pressure from the supplier's customer drove the parts supplier to batch inspecting via magnetic particle technique and redundant 200% visual inspection.

Using NDT-RAM, a Pass or Fail criteria template was developed from trial parts and then implemented as a quality inspection system. Cracks in flawed parts were easily detected using the NDT-RAM technique. The system offers objective whole part inspection.

One hundred percent part quality inspection via NDT-RAM assured objective and reliable inspection. Reliable design provided fast and efficient 24 hours per day, 7 days per week, 365 days per year operation with high throughput. As a result, both magnetic particle and visual inspection were eliminated on this part saving both time and money.



	Freq 1	Freq 2	Freq 3
Average Passed:	820.3	6717.8	16771
Std Dev Passed:	0	5.1	31
Average Failed:	1025.4	6843.8	16693
Std Dev Failed:	41	46.9	427.7
Passed - Failed	-205.1	-126.0	79.1



# INTEGRATE IN-LINE

## RAM SEMI-AUTOMATED SYSTEM

MODEL RAM-TEST-SEMI

- Seamlessly integrate into existing production lines
- Easy automation for testing with NDT-RAM software
- Repeatable impacts performed with industrial impactor
- Flexibility allows a variety of parts to run through the same line

The Modal Shop's RAM Semi-Automated System is the ideal system for easy integration into an existing production line. The system includes all of the core components of NDT-RAM, including the smart digital controller, industrial impactor, microphone, software and industrial PC. The system can directly interface with any programmable logic controller and become an integral piece of your existing quality inspection system.



## TEST TALK: DUCTILE IRON NODULARITY

The measurement of nodularity in ductile iron castings is time consuming and subjective by means of both visual sectioning and ultrasonic immersion. Often parts are repositioned on ultrasonic probes to gain a forced pass and additional steps and costs are incurred to prevent rust and oxidation after immersion.

NDT-RAM provides an extremely fast, whole body indication without immersion or part preparation. By impacting parts and windowing critical resonant frequencies, the system screens for parts exhibiting nodularity below your customer's critical specification.

Computerized testing with NDT-RAM ensures a simple, reliable, affordable means to screen for nodularity without the compounding troubles caused by immersion. Additionally, Resonant Inspection provides a whole body indication of nodularity rather than merely a local spot check.

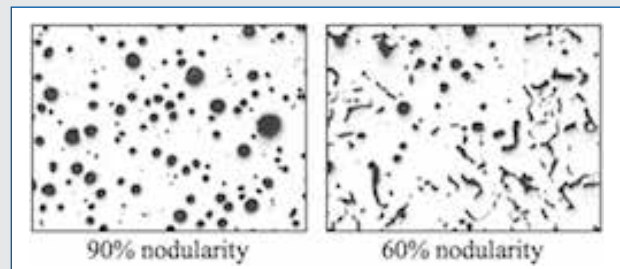
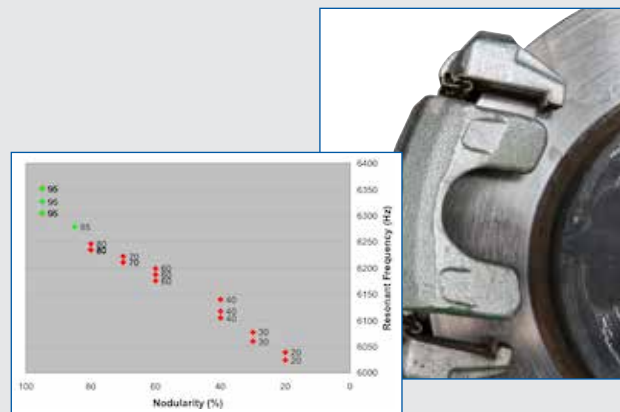

# TEST ON-SITE

## RAM MANUAL SYSTEM

MODEL RAM-TEST-MANUAL

- Ideal for use during design stages, troubleshooting and quarantine situations
- Portable for use on-site and in various locations around the facility plant
- Quality Departments can create test set-ups without production interruptions for Production Line use

The Modal Shop's RAM Manual System has all the core components necessary for Resonant Inspection, including a laptop, smart digital controller, manual impact hammer, microphone, software and rugged travel case. The system provides a completely portable solution for quality testing of a wide range of components and is ideal for spot testing, part investigation and troubleshooting.



## TEST TALK: NOISE VIBRATION HARSHNESS - NVH

As vehicle engineers have reduced engine and transmission noise levels, brake squeals, groans and other related issues have become an annoyance for the more demanding automotive buyer. Quieter is better. Automotive OEMs have established specifications for first natural frequencies for brake components that they expect their suppliers to measure and meet.

NDT-RAM provides an extremely fast, whole body NVH measurement. By impacting parts and measuring the first several natural resonant frequencies, brake components can be 100% tested for meeting and achieving sound quality requirements per OEM manufacturing specifications.

Market-wide warranty repairs for brake NVH claims exceed \$100 million annually in the U.S. Objective, economical Resonant Inspection with NDT-RAM ensures a simple, reliable, affordable means to screen for NVH resonant frequencies, meeting supplier demands and reducing warranty claims.

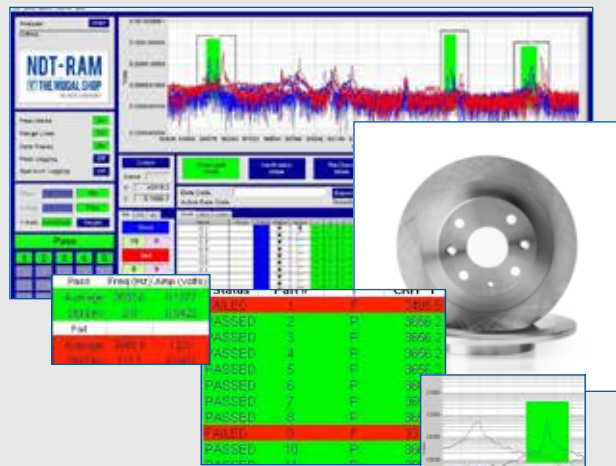

# CAPSTAN ATLANTIC A CASE STUDY

## SOUND WAVES THAT MEASURE QUALITY

NDT-Resonant Acoustic Method (NDT-RAM) offers an approach to product testing that presents distinct advantages to manufacturers. At least the people at Capstan Atlantic think so. For almost ten years now, they've been using NDT-RAM technology that utilizes sound to completely and reliably test product quality.

"The NDT-RAM unit we've employed in our manufacturing process has enabled us to provide 100% product testing," says Vice President of Engineering, Rich Slattery. "To put it simply, it provides a peace of mind that lets us sleep at night."

In its 100,000 square foot facility staffed by 230 employees, Capstan Atlantic produces a variety of structural parts for the automotive industry. But their niche is making multi-level, high-performance precision gears for automotive powertrain systems. They supply parts for the big three automotive makers in the United States as well as Japanese transplant facilities.



## THE PRESSING NEED OF GEAR PRODUCTION

Capstan Atlantic's production facility involves a complex metallurgy process that begins with an iron-based, powdered alloy. Additions such as chrome, nickel, molybdenum and graphite are added for strength, ductility and wear resistance. The powder blends are compressed to varying densities, depending on the requirements of the application. And the newly formed gears are then sintered on 65-foot continuous belt furnaces at a temperature of more than 2,000 degrees Fahrenheit. Although the methods Capstan Atlantic employs are very robust and effectively minimize the chance of defects, the process still requires a 100% test for structural integrity. Therefore, product testing is an essential element in the quality assurance program.



Prior to investing in the NDT-RAM unit, the company used a Non-Destructive, 100% torque test method. But it didn't deliver the level of performance and reliability that put their minds at ease. It was subject to human interpretation, it was very slow and therefore costly, and it didn't guarantee 100% conformance.

"We felt that the manual testing approach was too uncertain for us," says Senior Development Engineer, Eric Day. "Because of the demanding, highly competitive nature of our industry, we wanted a testing method that qualified every single component that left our facility. We found it with the NDT-RAM unit. It has made a powerful impact on our company and has significantly added to our peace of mind."

"Our previous method tested around 40 to 50 parts an hour," says Rich Slattery. "But the NDT-RAM unit tests 600 to 700 parts an hour. The improvement in the level of effectiveness and efficiency we've experienced with NDT-RAM is phenomenal!"





## A SOUND APPROACH TO PRODUCT TESTING

To understand how the NDT-RAM unit works, consider the operation behind a bell or tuning fork. When you strike either instrument, it vibrates, emitting a sound. An instrument that rings true produces a consistent sound. This consistency in sound reveals the structural integrity of the instrument. That is the basis for NDT-RAM technology. When struck by a tiny anvil, components such as gears emit a natural frequency as part of their structural response. This unique and measurable signature is then compared and analyzed against both good and bad product. Just like a cracked bell will not ring true as does a structurally sound bell, components can be tested in the same manner. If a gear is cracked, lacks the correct density or misses other characteristics of a structurally sound product, the flaw will be exposed when their signature deviates from what has been identified as good product.

The NDT-RAM unit tests the whole part for both external and internal flaws and provides an objective, quantitative analysis that



eliminates errors involving human interpretation and judgment through the use of sophisticated equipment. A dynamic sensor captures sound and a high-speed analog-to-digital converter translates the sound into measurable data. Since a defective part will shift in its structural resonance, this shift is identified when compared to pre-defined data. Essentially, the NDT-

RAM system listens to the structural response of a part and evaluates it against the statistical variation from a control set of good parts in order to screen defects.

The criterion used to represent pre-defined data is established by way of templates. The resonant signature of both good and bad product is captured in order to provide objective, measurable variables for comparison. Once these templates have been established through up-front programming, the NDT-RAM systems are self-regulating units that require little maintenance and eliminate the need for a trained operator. Even better, it's very fast.

"We've incorporated the NDT-RAM unit right on our assembly line," says Mr. Slattery. "It doesn't slow our production one bit. Components pass through it right before packaging. Any product that doesn't pass inspection is removed from the line automatically. Gears that pass inspection are immediately packaged and shipped in a streamlined operation."

Manufacturers need not worry about durability either. From the rugged microphone and industrial impactor to the NEMA smart digital controller, the NDT-RAM system is designed for industrial environments. Its durable, physical construction is perfect for plant floor high-volume test applications.

## BENEFITS THAT ARE RIGHT ON PITCH

For Capstan Atlantic, the NDT-RAM system not only contributes to peace of mind; it also contributes to the bottom line. According to Mr. Slattery, the NDT-RAM system the company currently uses saves the company "33 cents on each gear produced over the previous method." And since the company ships around 5,000 gears a day, that amounts to a total savings of \$1,660 per day. Furthermore, because the unit eliminates the need for a specially trained operator, it also reduces personnel costs. But the best part is in knowing the company has achieved the highest level of quality assurance possible.



## NDT-RAM IN ACTION

“When I go home at the end of the day, I don’t spend the night worrying about whether or not a gear slipped through our quality system and was shipped to a customer because I know every single gear produced on our line has been thoroughly and completely tested. It’s hard to put a price tag on that,” says Mr. Slattery. “But it is easy to figure the consequences involved in a field failure. That’s every manufacturer’s worst nightmare.”

For Capstan Atlantic, a defective part in a drive train system represents a customer “walk home.” In other words, the automobile breaks down leaving the occupants stranded. In this scenario the cost of tear down and customer reimbursement easily exceeds the purchase price of the NDT-RAM unit. But that’s really only the minimum effect. It involves proving that the defective part was an isolated event. Because otherwise, it might result in a recall—an ordeal that could easily put a company out of business.

“With our present system in place, I’m confident that everything checks out as it should,” says Eric Day. The level of quality assurance is far superior to our previous method. “I guess you can say the NDT-RAM unit has allowed us to walk away from worrying about walk home field failures,” says Mr. Slattery. “Since it’s been in place, we’ve enjoyed 100% success.”

Although there was a learning curve initially, once Capstan Atlantic mastered the new system, the company found it relatively easy to use. And not only did it require less engineering support, but the data captured by the NDT-RAM system also provided feedback that contributed to other quality improvements. “We discovered that additionally, the unit has enabled us to recognize things about our process and make improvements upstream that have increased our product yield by reducing process variation,” says Mr. Slattery.

Today the people at Capstan Atlantic sleep easier because they have complete confidence in their NDT-RAM unit. Backed by state-of-the-art technology that delivers precise, 100% testing, it reduces both their worries and their costs.

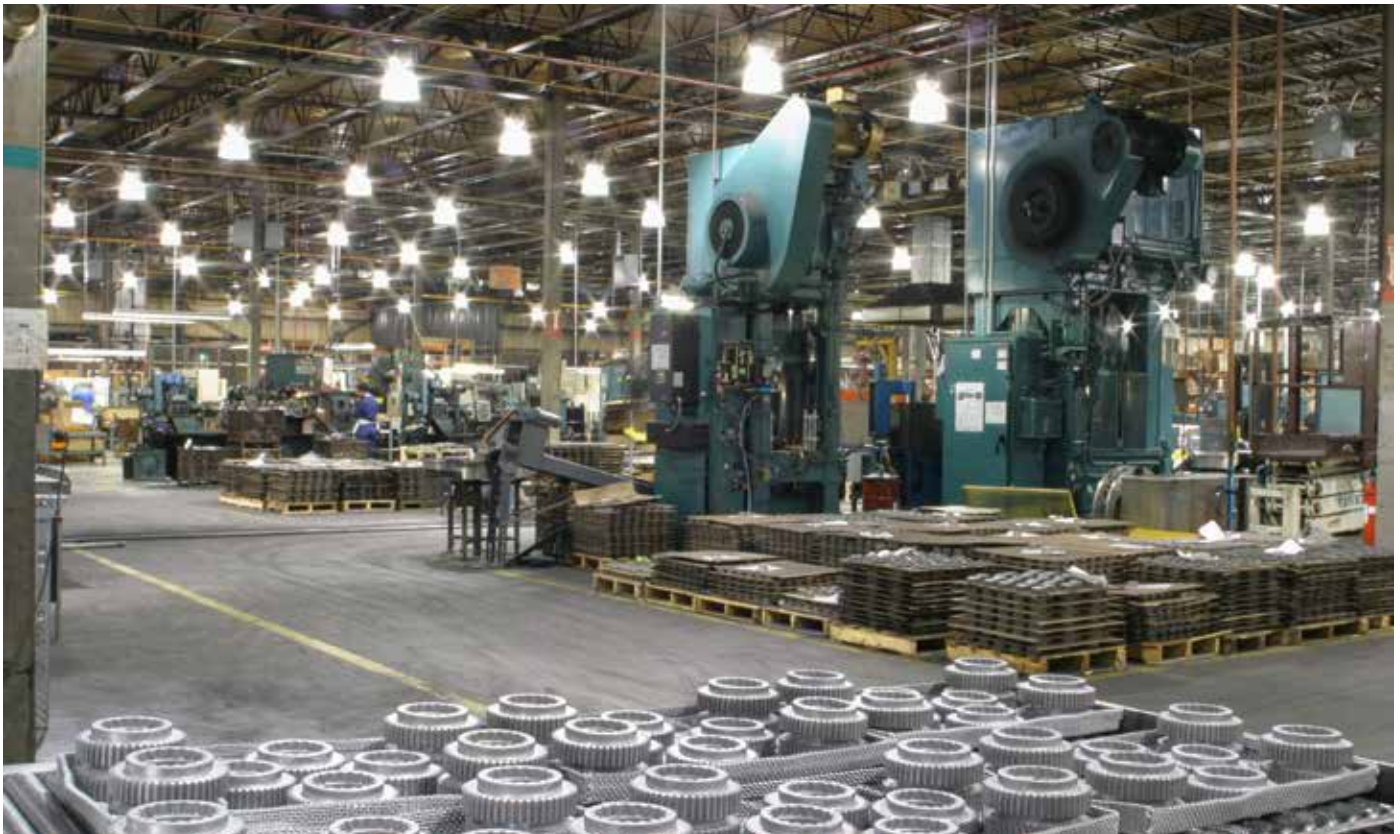

# NDT-RAM TESTIMONIALS



## ACCEPTED STANDARD

“NDT-RAM, per [ASTM E2001](#), is a resonant ultrasound method for **defect detection** in both metallic and non-metallic parts”

## VERSATILE AND RUGGED

“We have tested **over 2 million parts** with NDT-RAM and have **not had any rejects** at the customer”



## INDUSTRY ADOPTED

“Major automotive suppliers have added **Resonant Frequency** as an acceptable test method for **nodularity verification** on both their blueprints and engineering standards”

## ACCURATE

“We felt that the **manual testing** approach was **too uncertain** for us, NDT-RAM has made a powerful impact on our company and significantly **added to our peace of mind**”

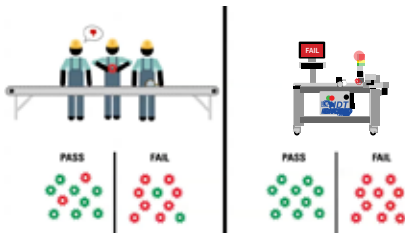

## TRUST-BUILDING

“NDT-RAM eliminated the insecurity of not having a **100% in-line inspection** method for **crack detection** of a very critical product line”



## ECONOMICAL INVESTMENT IN PROCESS IMPROVEMENT

“NDT-RAM has enabled us to recognize things about our process and make improvements **upstream** that have **increased** our **product yield** by **reducing process variation**”



**THE NDT-RAM TEAM IS HERE TO MAKE 100% QUALITY INSPECTION A REALITY FOR YOU**



## A SMART AND SAFE CHOICE

“To put it **simply**, NDT-RAM provides a **peace of mind** that lets us **sleep** at night”

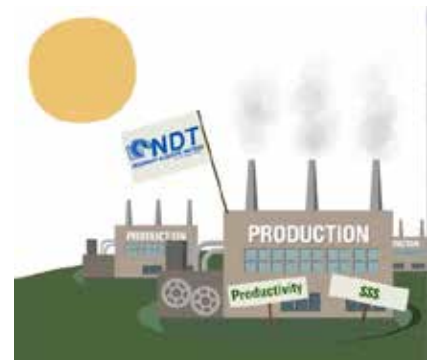

View “**NDT-RAM ANIMATED**” at [www.ndt-ram.com](http://www.ndt-ram.com)



**10310 Aerohub Boulevard, Cincinnati, OH 45215 USA**

modalshop.com | info@modalshop.com | 800 860 4867 | +1 513 351 9919

© 2021 PCB Piezotronics - all rights reserved. PCB Piezotronics is a wholly-owned subsidiary of Amphenol Corporation. Endevo is an assumed name of PCB Piezotronics of North Carolina, Inc., which is a wholly-owned subsidiary of PCB Piezotronics, Inc. Accumetrics, Inc. and The Modal Shop, Inc. are wholly-owned subsidiaries of PCB Piezotronics, Inc. IMI Sensors and Larson Davis are Divisions of PCB Piezotronics, Inc. Except for any third party marks for which attribution is provided herein, the company names and product names used in this document may be the registered trademarks or unregistered trademarks of PCB Piezotronics, Inc., PCB Piezotronics of North Carolina, Inc. (d/b/a Endevo), The Modal Shop, Inc. or Accumetrics, Inc. Detailed trademark ownership information is available at [www.pcb.com/trademarkownership](http://www.pcb.com/trademarkownership).